

BARGO

Art.-Nr.

307 069
307 070

↔	1500
↕	2000
↗	590
	mm

1/9

vO

	120 min			PZ2, PZ1	0,5 kg	3m	600 mm	Ø8

ID	ID	Image	Image	Image
18530	②	569*1882*16	1x	4/4
18531	③	568*484*16	1x	4/4
18532	④	481*569*16	1x	4/4
18533	⑤	569*1466*16	1x	3/4
18534	⑥	82*1466*16	2x	3/4
18535	⑦	1980*570*16	1x	1/4
18536	⑧	1980*570*16	1x	1/4
18537	⑨	590*1500*16	1x	3/4
18539	⑩	1910*497*3	3x	1/4
18538	⑪	560*475*16	4x	4/4
18541	⑫	1884*496*16	2x	2/4
18542	⑬	1404*496*16	1x	2/4
18543	⑮	156*496*16	3x	2/4
18544	⑯	500*100*16	3x	3/4
18545	⑰	100*426*16	3x	3/4
18546	⑱	500*100*16	3x	3/4
18547	⑲	506*456*3	3x	1/4

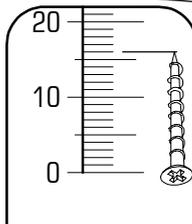
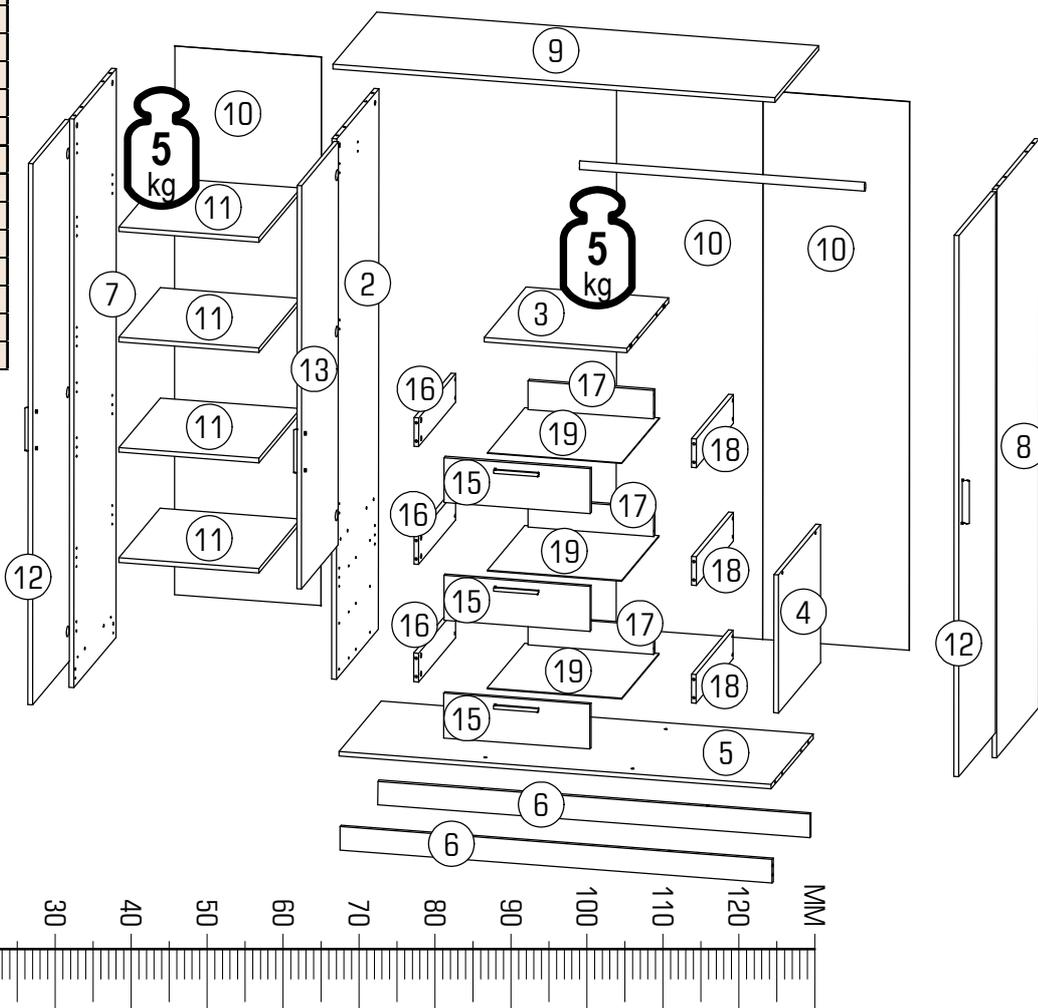
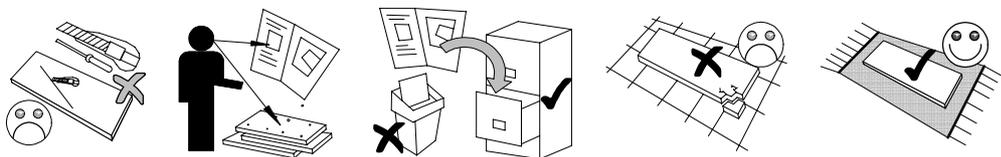

A 75x	B 1x	C 22x	D 48x	E 11x	F 20x	G 12x	H 22x	I 3.0	J 1x
K 22x	L 8x	M 1x	N 16x	P 26x	Q 2x	R 26x	S 24x	T1 18x	
T2 4x	U 6x	V1 6x	V2 6x	W1 3x	W2 3x	X 1x	Y1 3x	Y2 3x	

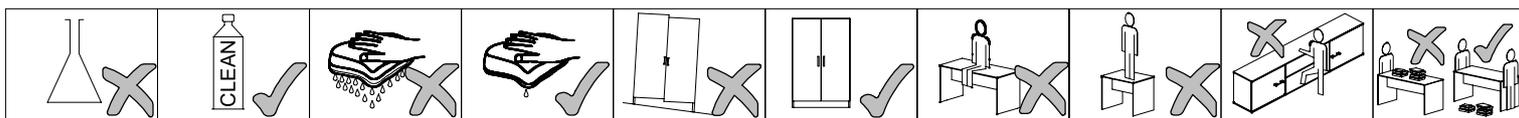

																	
D	9x	F	4x	K	6x	N	8x	P	2x	Q	1x	S	24x	W2	3x	Y1	3x

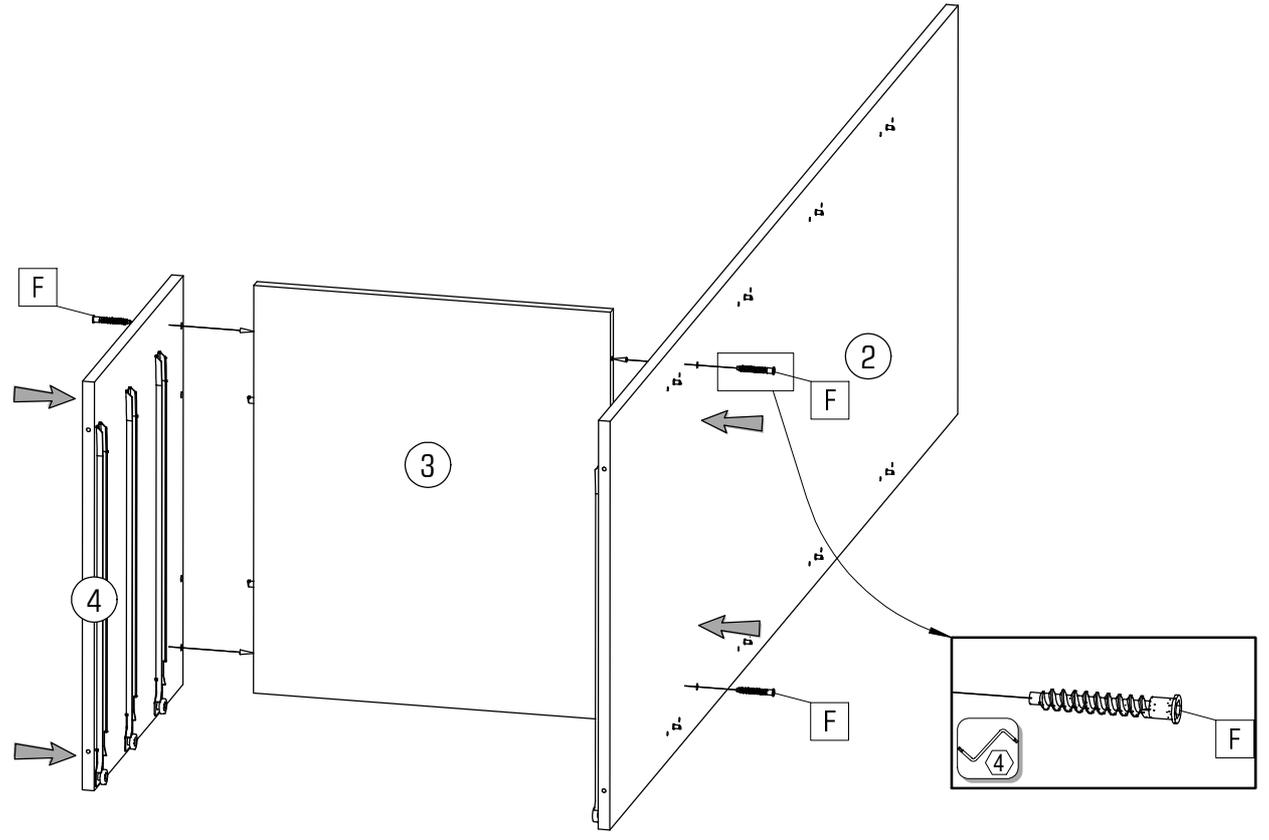
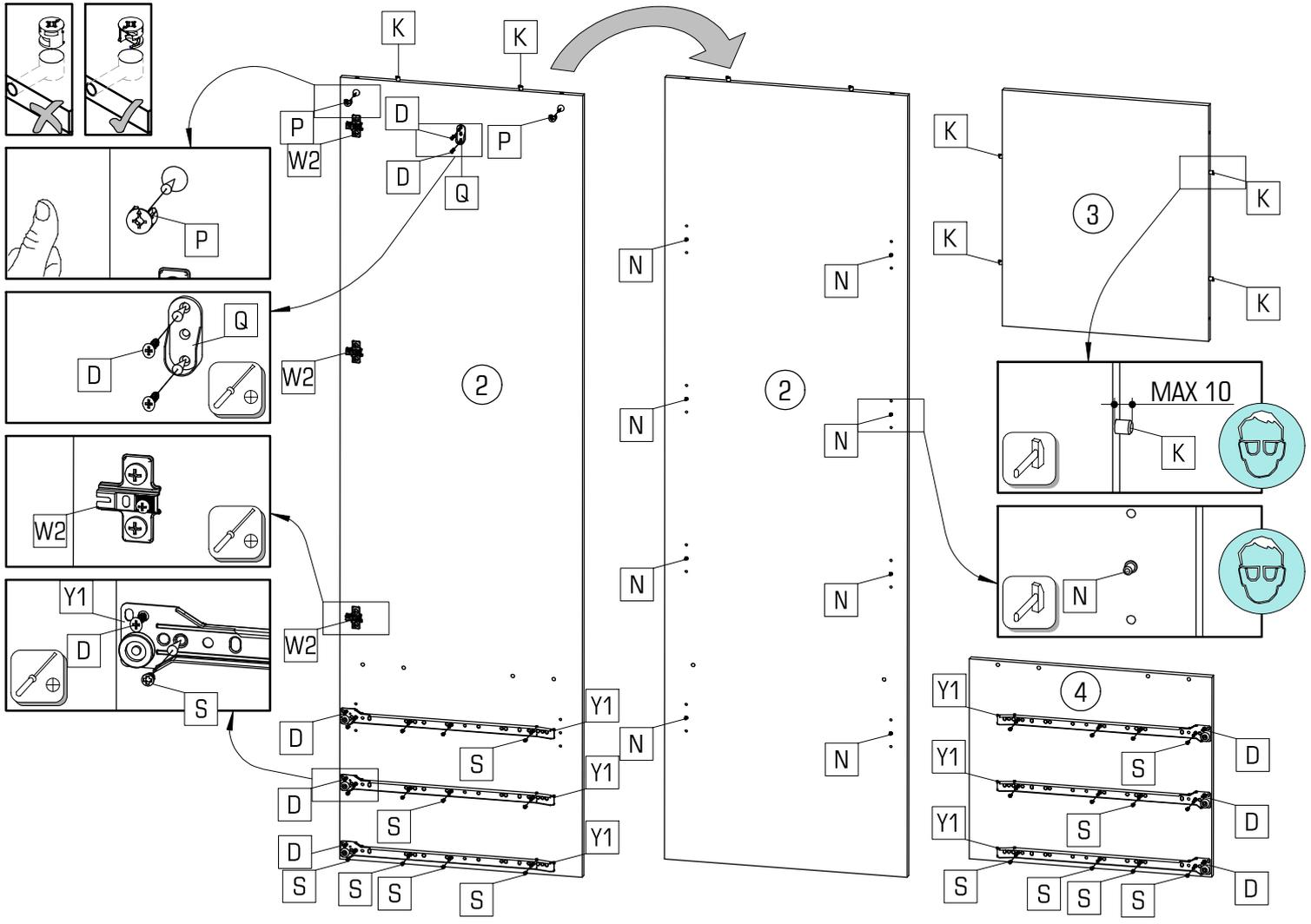

		
F 4x	K 4x	P 4x

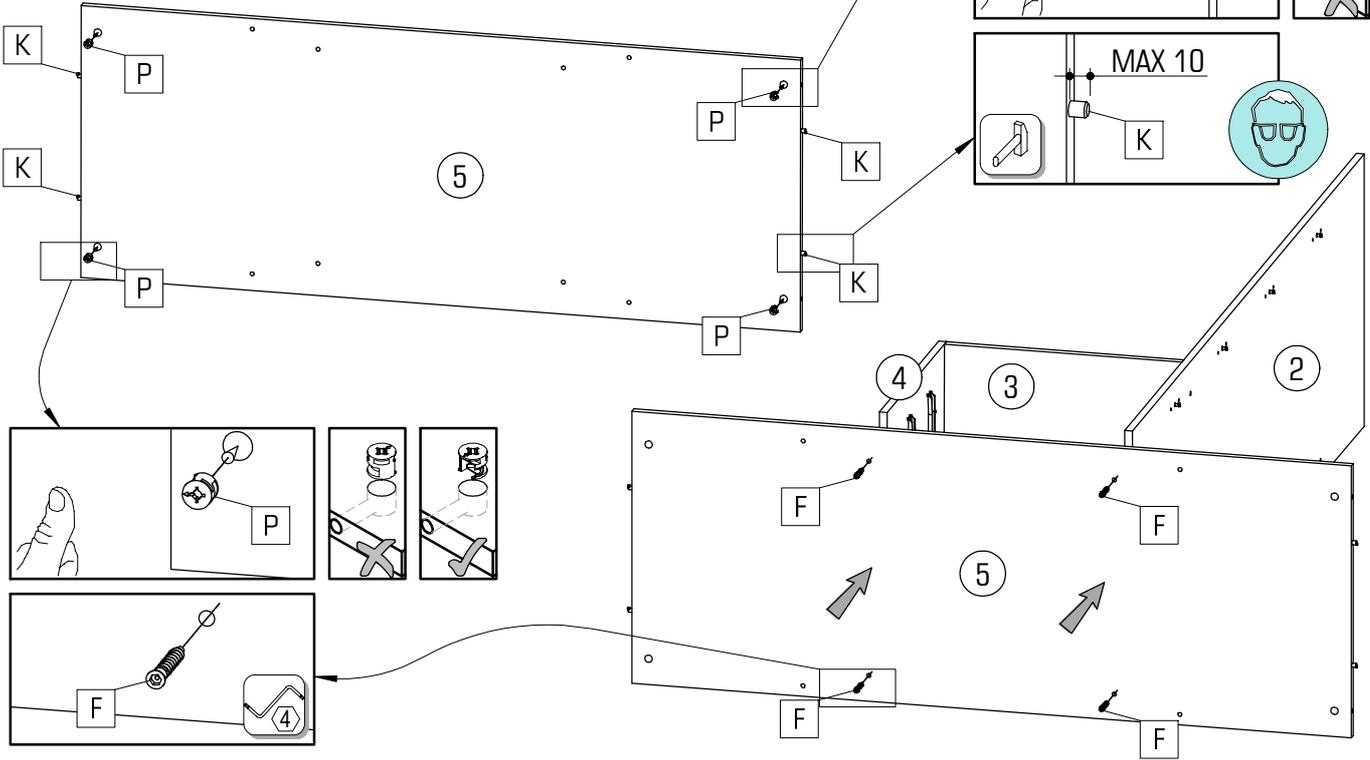

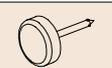
		
K 8x	L 4x	P 4x

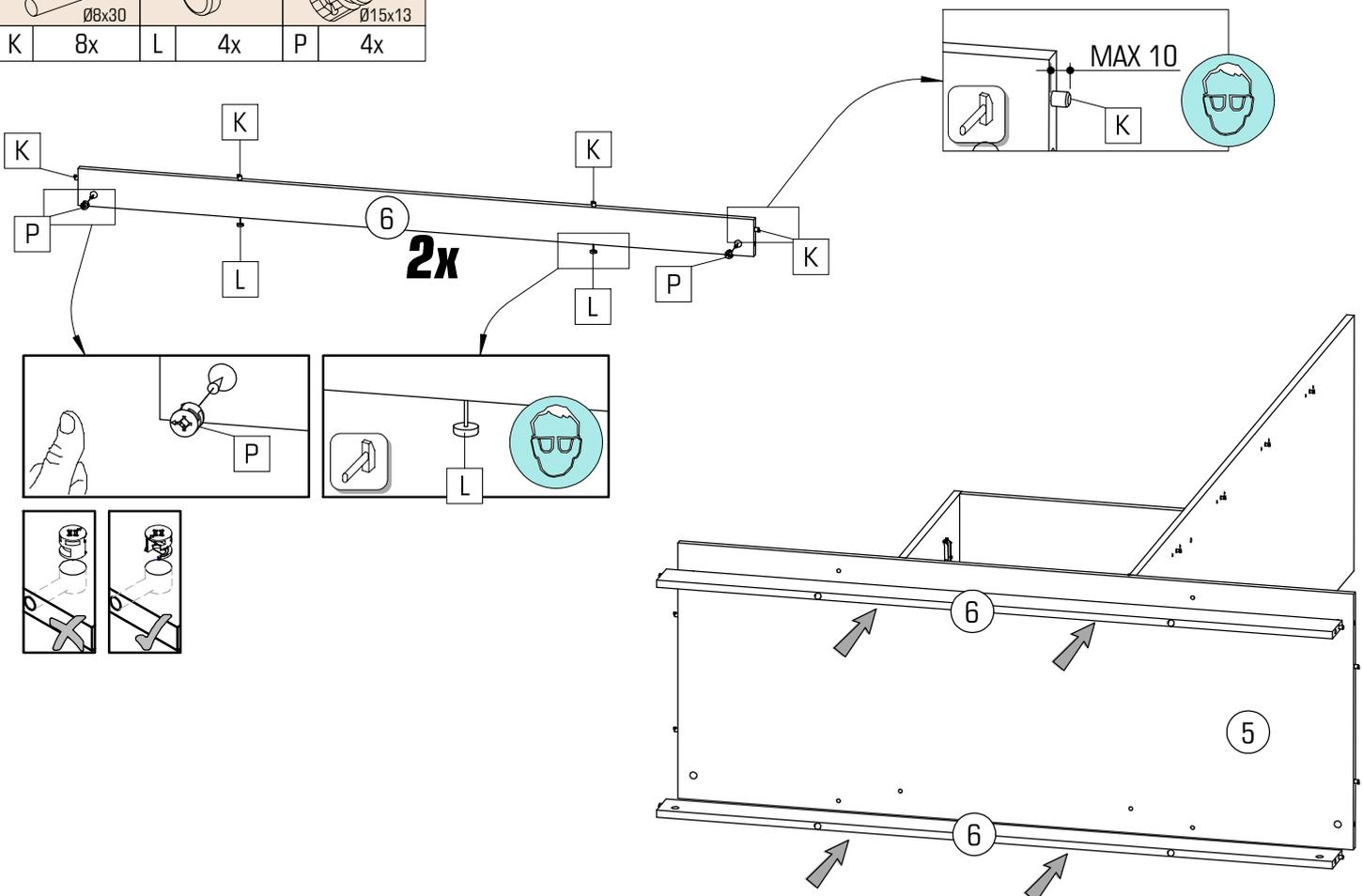

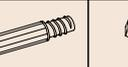
							
D	K	L	N	P	Q	R	V2
3x	4x	4x	8x	4x	1x	8x	6x

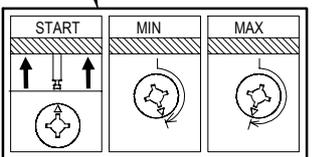
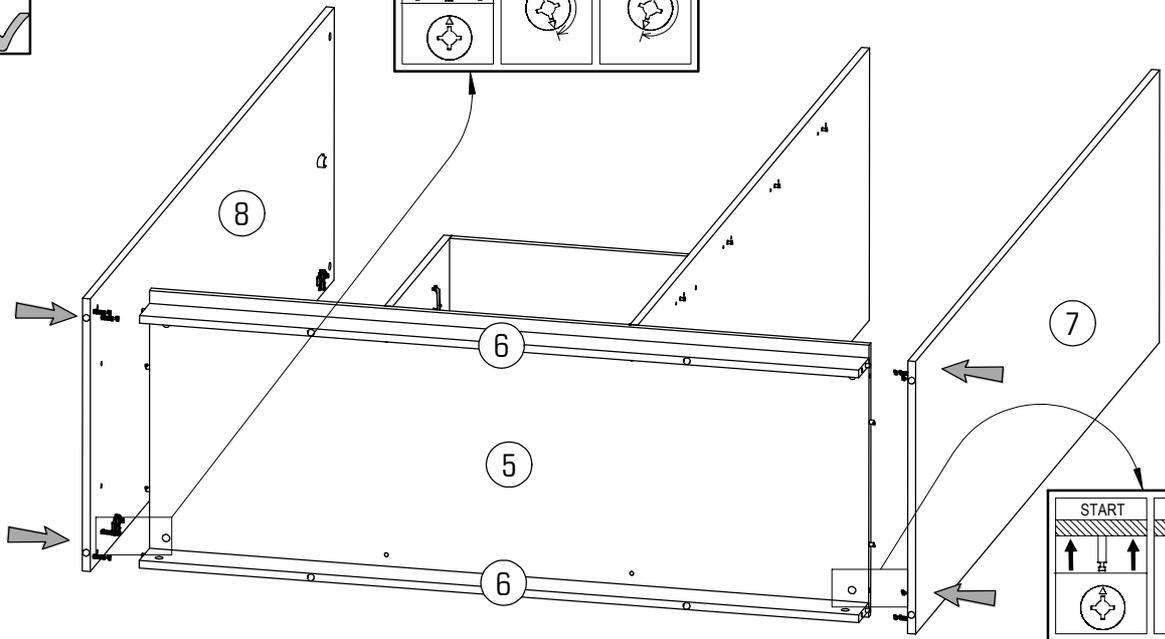
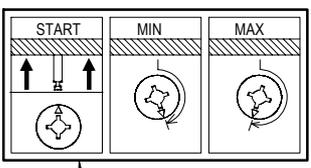
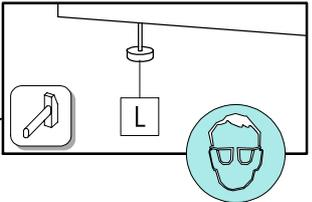
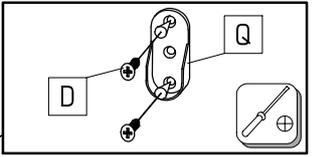
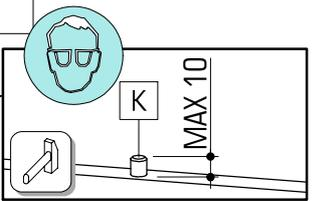
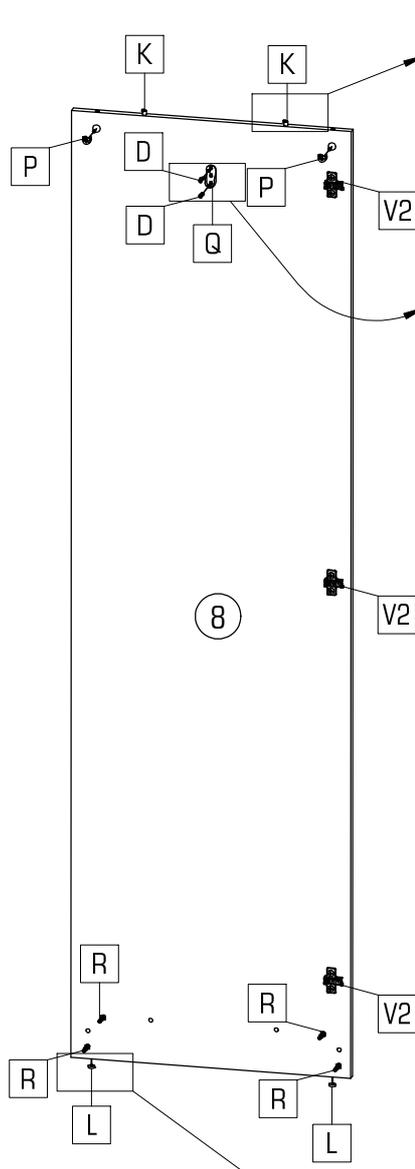
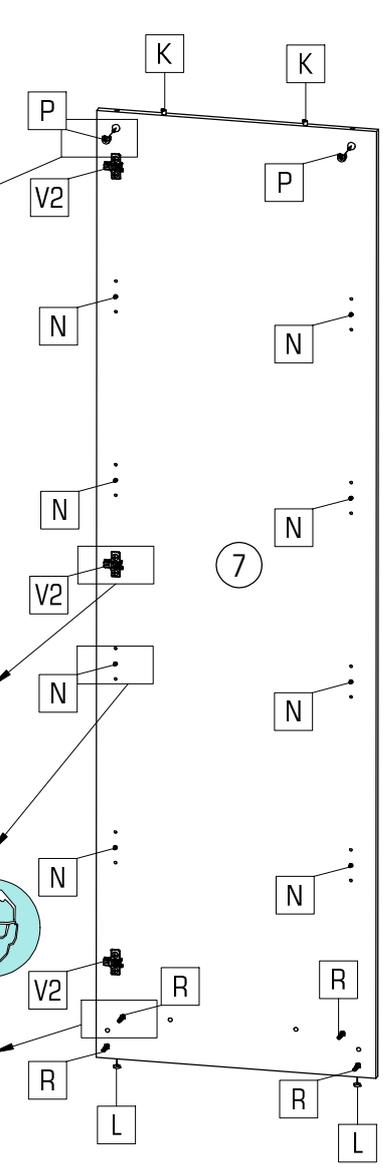
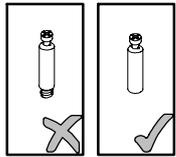
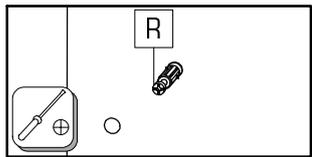
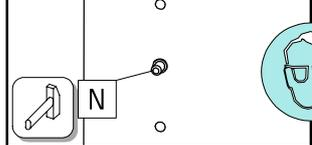
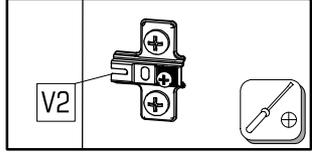
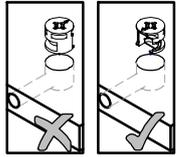
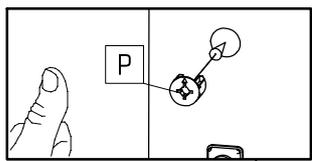

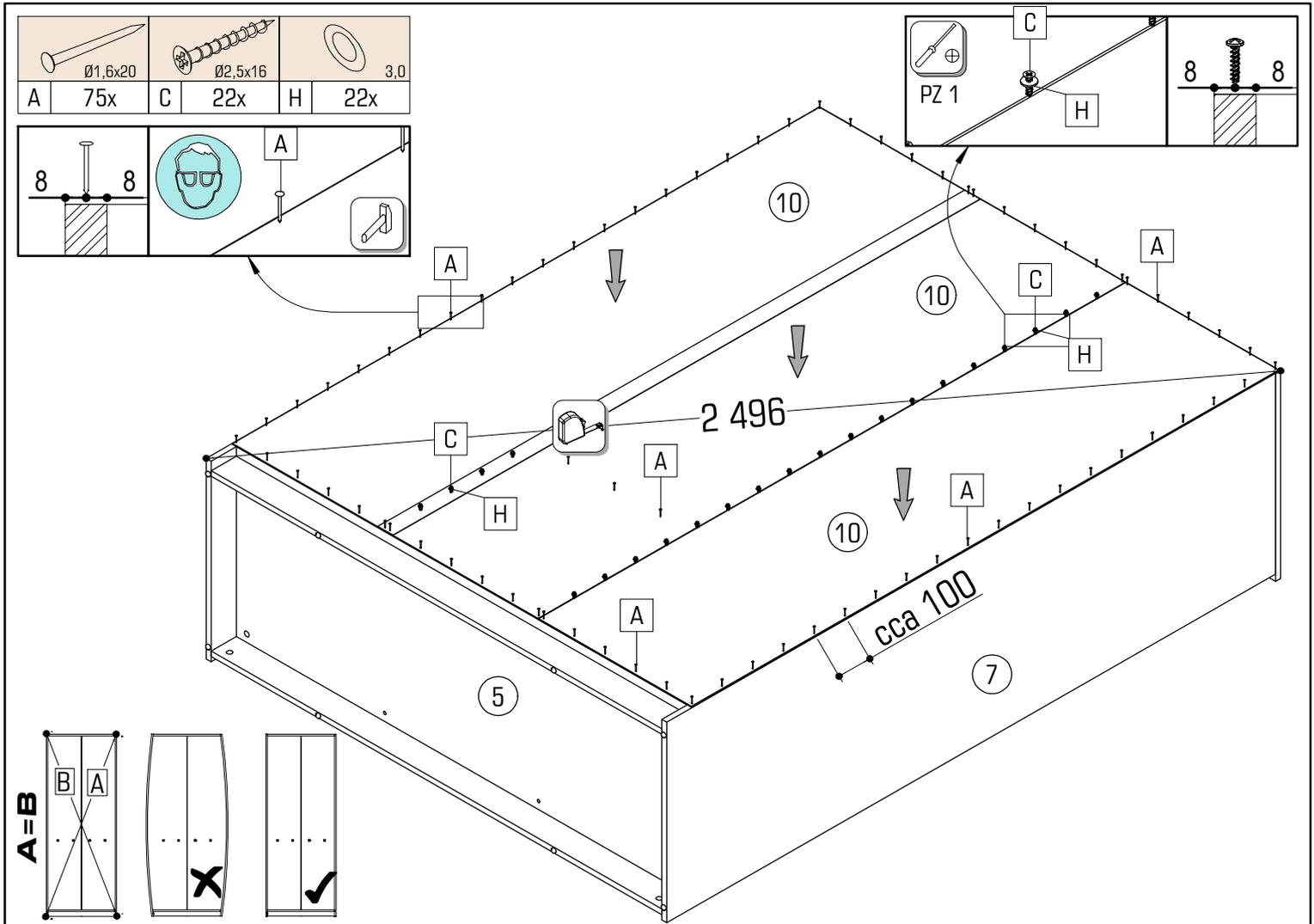
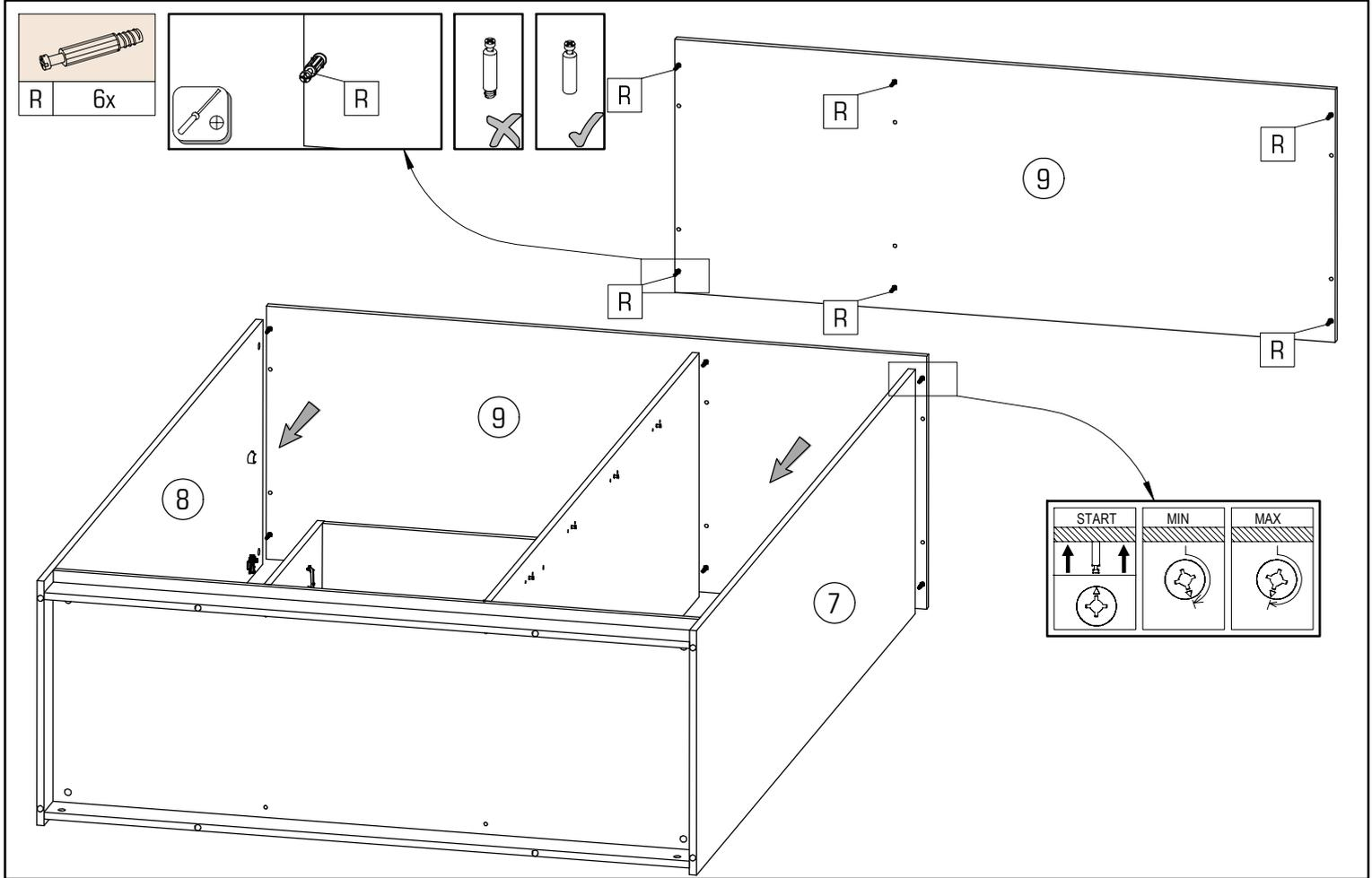

					
B	E	J	M	T1	T2
1x	2x	1x	1x	6x	4x

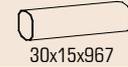
X
1x

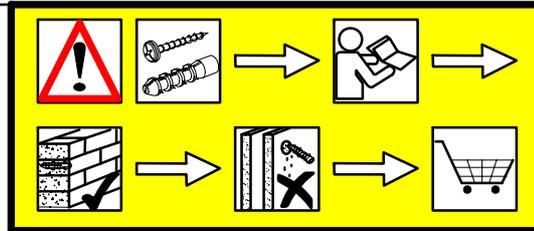

Upozornenie! Pevnosť steny sa musí pred montážou bezpodmienečne skontrolovať. Univerzálne hmoždenky, ktoré sú obsiahnuté v balení, používajte jedine pre pevné murivo ako je betón/tehla. Hmoždenky sa nesmú používať v prípade ľahkého stavebného muriva, dutina tehla, u sádrokartónových dosiek alebo iných konštrukcií rámu. U týchto murív je nutné použiť špeciálne hmoždenky! Tieto je možné dostať v špeciálnych predajniach so stavebným materiálom (stavebniny). Pri nedodržaní pokynov nepreberajú výrobcovia/predajci a dodávateľa zodpovednosť za vzniknuté škody.

Upozornění! Před montáží je nutné zkontrolovat stav stěny. Přiložené univerzální hmoždinky jsou určeny pouze k použití pro pevné zdivo jako beton/cihly. Hmoždinky do zdi se nesmí používat u dutinová cihla, zdiva jako pórovitý stavební kámen, sádrokartónová deska nebo jiný měkký materiál. U těchto zdiv jsou nutné použít speciální hmoždinky! Jsou k dostání v speciálních prodejnách se stavebním materiálem. Při nedodržení těchto pokynů výrobce/prodejce a dovozce neručí za způsobené škody.

Pažnja! Prije montaže obavezno provjerite svojstvo zida. Priložene univerzalne tiple namijenjene su isključivo za masivne zidove od betona/opeke. Tiple za masivne zidove ne smiju se koristiti za zidove kao npr šupljina opeka laki sastavni elementi, gips-kartonske ploče ili drugi modularni načini gradnje. Za te zidove potrebne su eventualno specijalne tiple! Iste su dostupne u specijaliziranim trgovinama građevinskim materijalom. U slučaju nepridržavanja prethodno navedenih napomena, proizvođač/trgovac i uvoznik ne preuzimaju odgovornost!

Achtung! Die Wandbeschaffenheit ist vor der Montage unbedingt zu prüfen. Die beigelegten Universaldübel sind ausschließlich nur zur Verwendung für festes Mauerwerk wie Beton/Ziegel. Die Mauerdübel dürfen nicht bei Mauerwerk wie Hohlraumziegel, Leichtbausteinen, Gipskartonplatte oder anderer Rahmenbauweise verwendet werden. Bei diesen Mauerwerken sind gegebenenfalls Spezialdübel zu verwenden! Diese sind in einem Fachgeschäft (Baumarkt) erhältlich. Bei Nichteinhaltung wird seitens Produzenten/Händler und Importeur keine Haftung übernommen.

Vigyázat! Szerelés előtt a falfelületet feltétlenül vizsgálja meg. A mellékelt univerzális tipl kizárólag stabil falazathoz használható mint például beton/tégla. A fal tipl nem használható könnyű építőkövekhez, üreg tégla, gipszkarton lapokhoz vagy más fávázás építményekhez. Ezekhez a falfelületekhez csak speciális tiplik használhatóak, melyek szaküzletekben (barkácsáruházakban) beszerezhetőek. Fentiek figyelmen kívül hagyása esetén a gyártó/kereskedő vagy forgalmazó nem vállal felelősséget.

Uwaga! Ścianę należy sprawdzić przed montażem. Dołączone uniwersalne kolki rozporowe są odpowiednie tylko do stosowania w mocnych murach, takich jak beton lub cegła. Nie rób z pomocą kółków rozporowych murowanych, takich jak pustak, lekka kostka, powierzchnie takie jak płyty gipsowo-kartonowe lub inne systemy ram. Jeśli dotyczy, muszą to być określone kolki rozporowe być użytych! Są one dostępne w specjalistycznym sklepie (sklepie ze sprzętem) niezgodność, producent / sprzedawca lub importer nie ponoszą odpowiedzialności.

Prudentă! Zidul trebuie examinat înainte de asamblare prizele de perete sunt adecvate numai pentru utilizarea în zidărie fermă, cum ar fi betonul bloc sau cărămidă. Nu folosiți zidăria zidurilor de perete, cum ar fi caramida goală, blocul ușor, suprafețe cum ar fi gips-carton sau altă încădrare sisteme. Dacă este cazul, trebuie folosite anumite prize de perete! Acestea sunt disponibile la un magazin specializat (magazin de hardware). În caz de nerespectare, producătorul / vânzătorul cu amănuntul sau importatorul nu își asumă răspunderea.

Увага! Стан стіни необхідно перевірити перед установкою. Укладені універсальні дюбелі призначені лише для використання з фіксаціями Кладка, як бетон / цегла. Анкери для стін не повинні використовуватися для кладки Порожни цегли, легкі будівельні блоки, гіпсокартон або інша каркасна конструкція бути використаними. З цією кладкою можуть застосовуватися спеціальні дюбелі використання! Вони доступні в спеціалізованому магазині (магазині апаратних засобів) Виробник / дилер та імпортер не несе відповідальності.

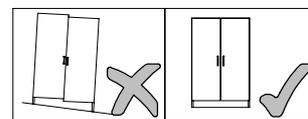
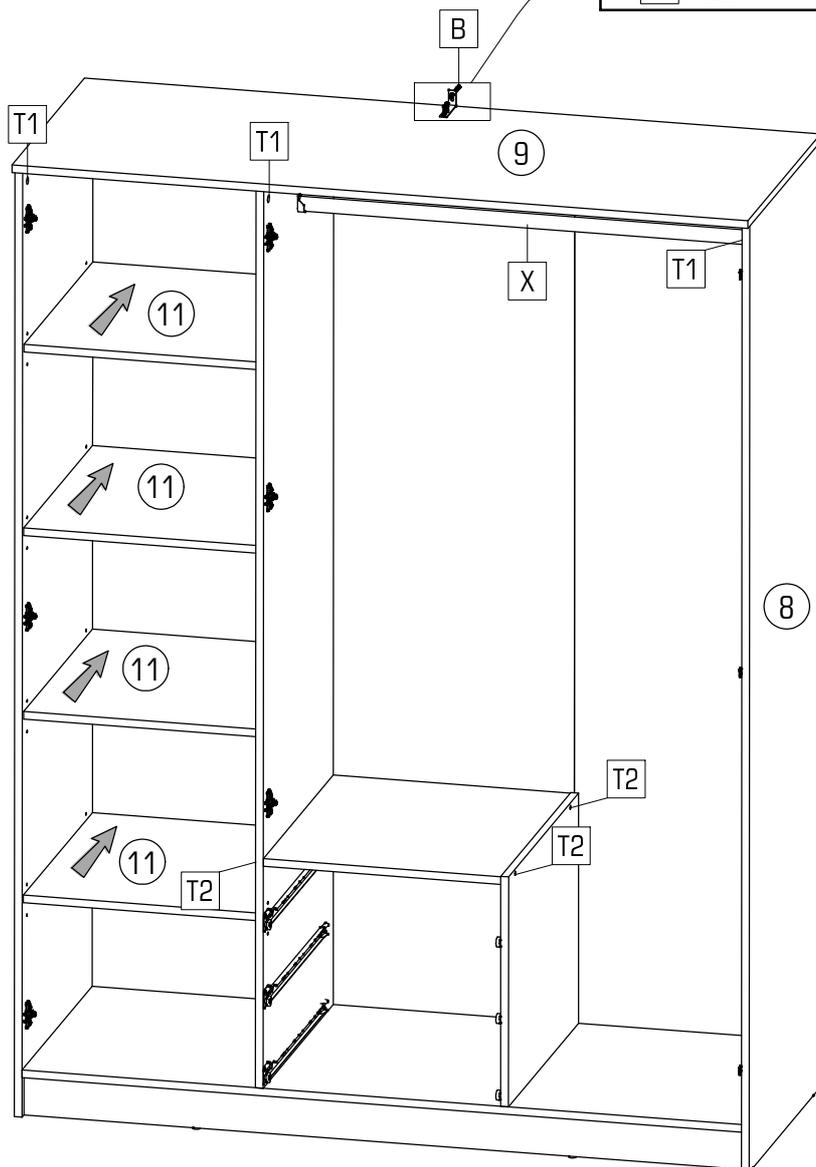
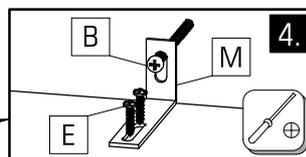
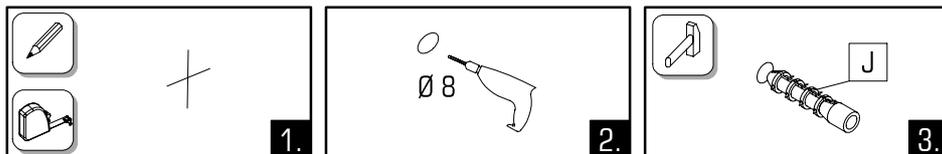

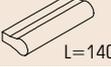
				
Ø3,5x15	Ø4x25	L=140		
D 18x	G 6x	U 3x	V1 6x	W1 3x

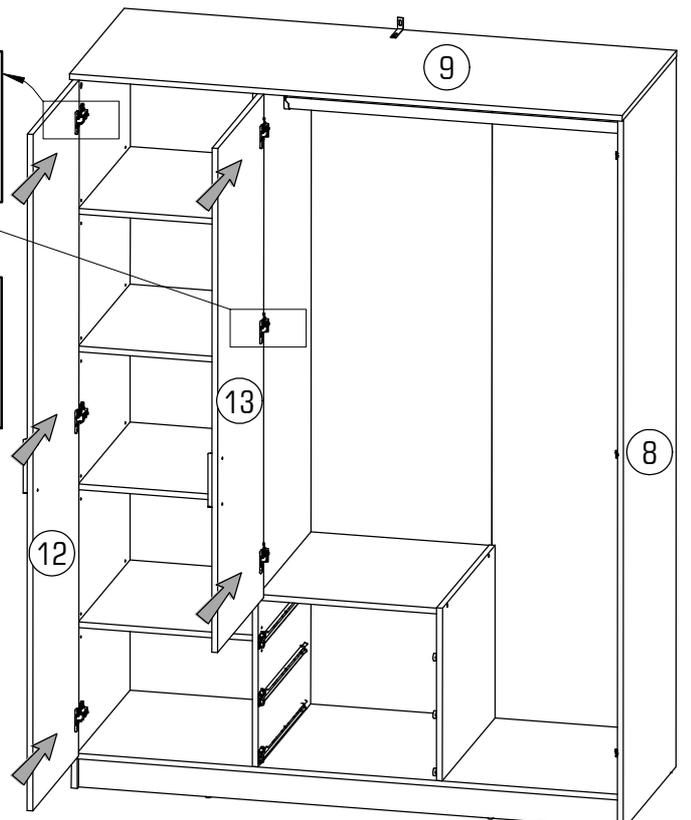
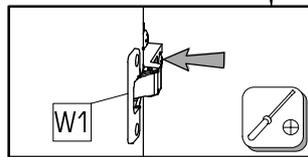
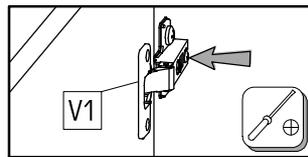
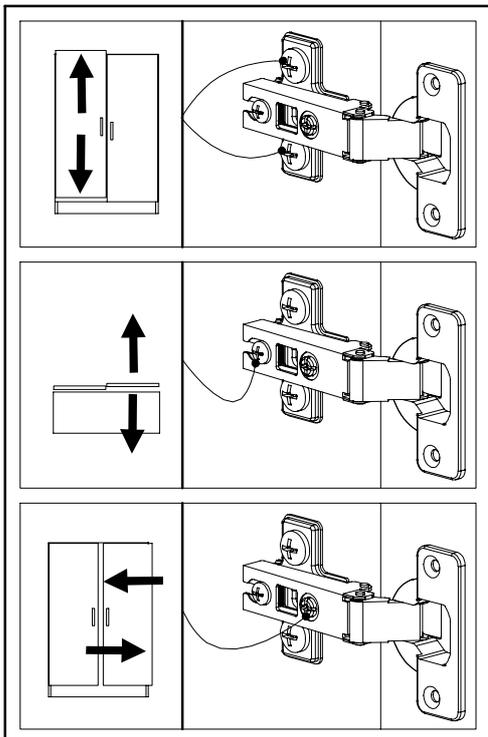
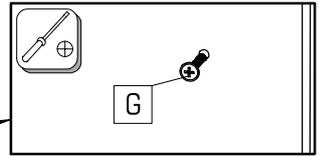
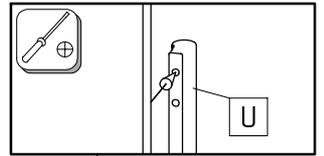
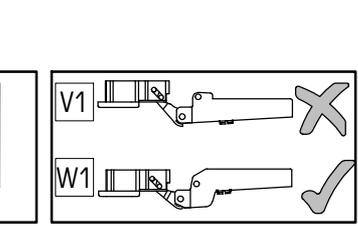
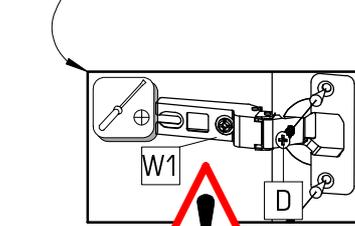
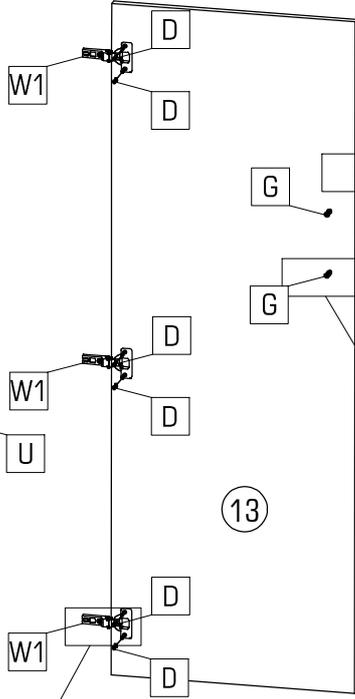
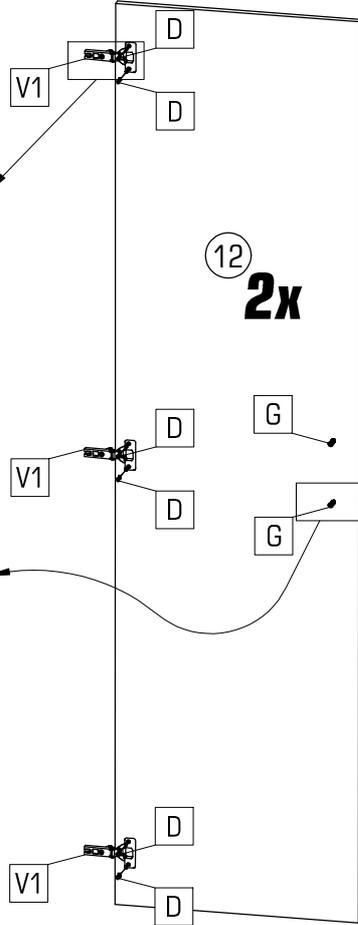
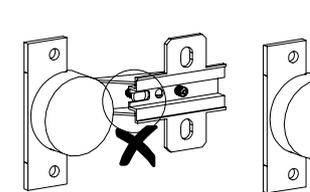
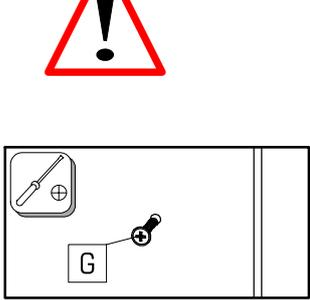
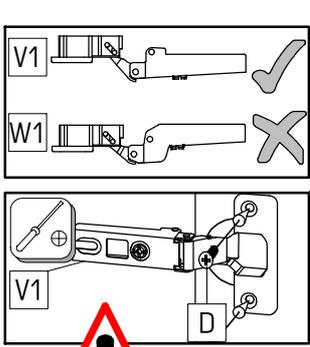

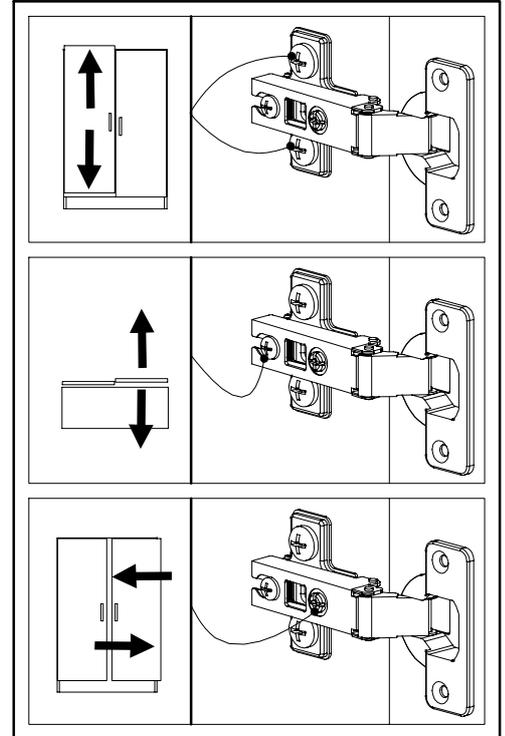
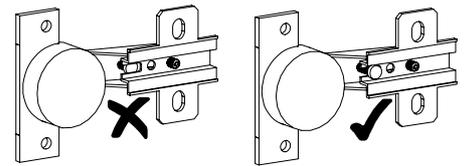
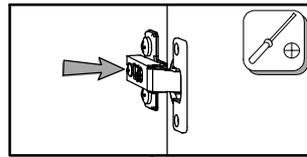
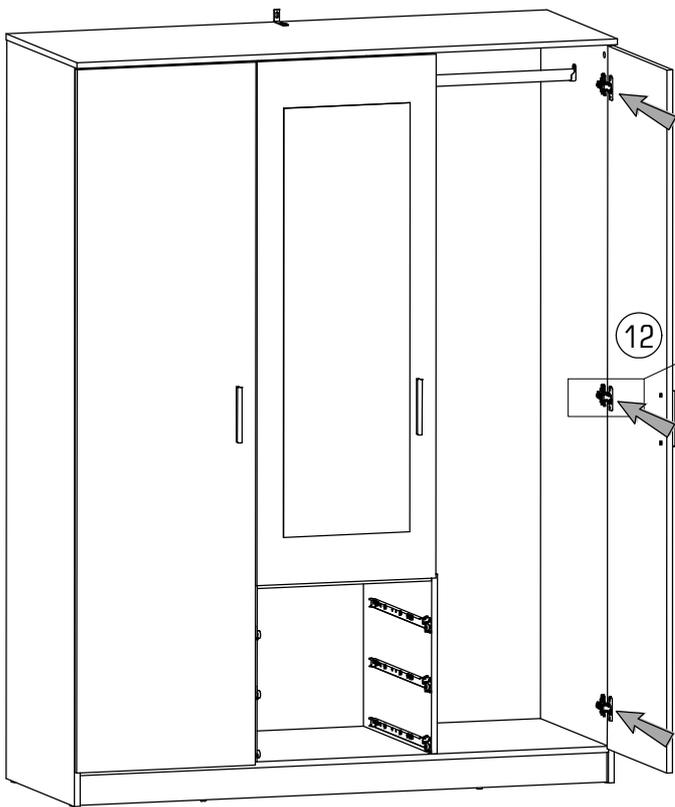

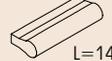
	Ø7x50		Ø4x25		Ø15x13		L=140		
F	12x	G	6x	P	12x	R	12x	U	3x

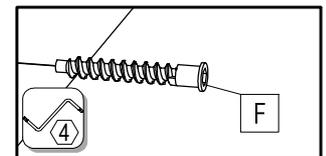
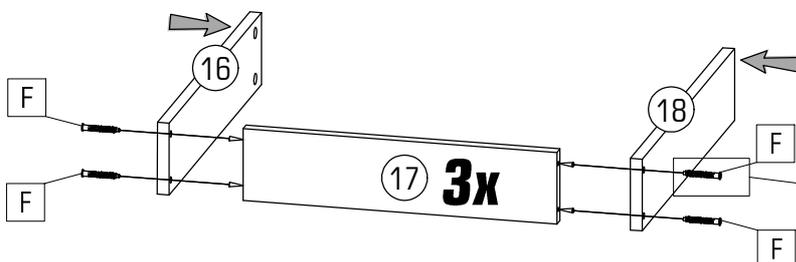
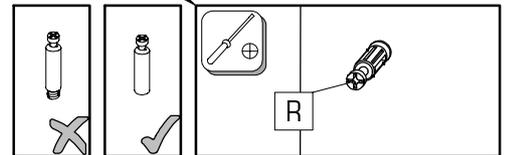
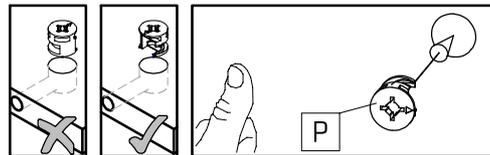
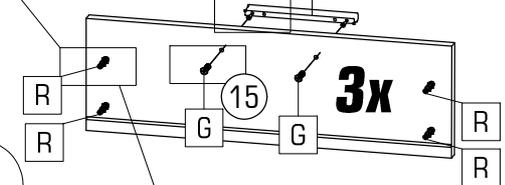
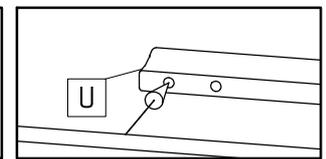
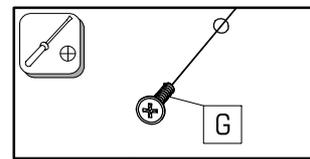
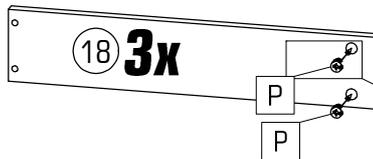
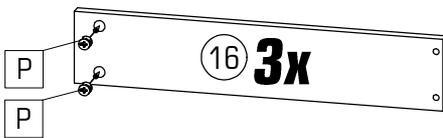

 Ø3,5x15	 Ø3,5x16		 L=500
D 18x	E 9x	T1 12x	Y2 3x

